

STANDARD BALL BEARINGS

Part #	O.D.	I.D.	Reference #
BB975	1.125	.500	R8-RS
BB971	1.374	.625	99502H
BB162ZZ	1.375	.5625	1622-2RS
BBR58	1.375	.625	499502H
B975	1.574	.669	6203-2RSC3
BBR95	1.781	.750	Z9504AB
BB974	1.851	.787	6204-2RS



FLANGED BALL BEARINGS





Part #	O.D.	I.D.
BB50	1-3/8	1/2
BB601*	1-1/8	1/2
BB58	1-3/8	5/8
BB34	1-3/8	3/4
BB207	1-3/8	3/4
BB716*	1-1/8	7/16
BB205	1-3/8	9/16

* Use in our steel semi-pneumatic wheels









UNIVERSAL

Part #	Replaces OEM #	Application/Description
BB162ZZ		Edger shaft bearing 1.375" OD x .5625" ID x .4375" W 1622ZZ, Sears, Western Tool and others
BB6200ZZ		Edger shaft bearing 1.181" OD x .3939" ID x .3543" W 6200ZZ, K & S (Trim-All) and others
BBR58	Ariens # 54161 Ariens # 54162 Snapper # 1-0756	Sealed w/c-clip retainer ring 1.375" OD x .625" ID 499502H
B58ES		Bronze bushing for edger shafts 3/4" OD x 1/2" ID x 3/4" W, 15/16" Flange OD, 1/8" thick Use on K&S edgers and others, Velke wheel bushing







AMF - See Noma

ARIENS

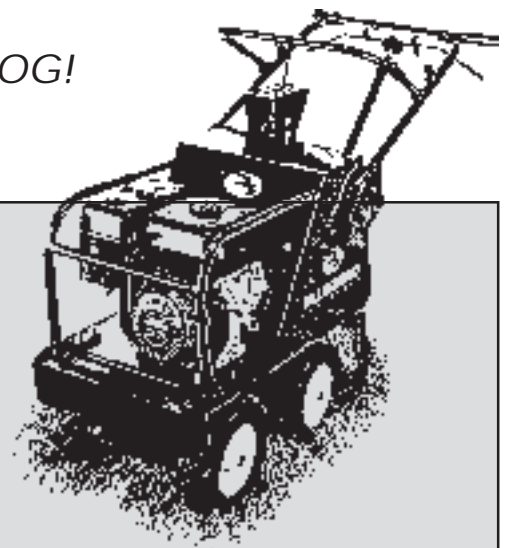



Part #	Replaces OEM #	Application/Description	
BB981	ARIENS # 54063	Bearing Snowthrower input shaft support bearing. Use on models 824, 932 and 1032. Model numbers: 924022, 024, 026, 028, 029, 032, 046, 048, 050, 072, 074, 075, and 079. ID: 3/4", OD: 1-3/4", Width: 1/2"	
BB971	ARIENS # 54039	Bearing Friction disc bearing on riding mowers. Drive plate bearing on walk mowers and snow blowers. Jackshaft bearing on 32" mowers, models 936006 and 301 and 40" mowers Models 936008, 009, 010, 011, 012, 013, 302, 303, 304 ID: .625, OD: 1.374, Width: .43	
BB95	ARIENS # 54069	Bearing cone and race kit Tine shaft bearing on rear tine tillers and many front tine models ID: 1", OD: 1.988", Width: .608"	
BB207	ARIENS # 54162	Bearing Rear height adjuster bearing on walk-behind mower Model 911022 ID: 3/4", OD: 1-3/8"	
B975	ARIENS # 54188	Bearing For double aluminum intermediate drive pulley on 93700 series snowblowers ID: .669, OD: 1.574, Width: .47"	
BBR95	ARIENS # 54073 ARIENS # 54120	Bearing PTO bearing on 934000 tractors, 1989-95 Model HT18. Spindle bearing on all mower decks. Chain case drive shaft bearing on 32" tiller attachment. ID: .75", OD: 1.781", Width: .6075"	

CALL FOR COMPLETE BLUEBIRD CATALOG!



AUTHORIZED DEALER • SEE PAGE 1





AYP/ROPER/SEARS

Part #	Replaces OEM #	Application/Description	
BBG79	AYP # 625J	Bushing ID: .75, OD: 1.375, Width: .625	
BB162ZZ	AYP	Bearing Fits many Sears brand edgers ID: .5625, OD: 1.375, Width: .4375	
DB981	AYP # 126847X	Drag link bushing for front engine riders	
B975	AYP # 110485X	Bearing Top bearing in triangle style quill assembly, SS # 82-225 Fits in our # 82-677, # 82-678 and # 82-691 quill assemblies ID: .669, OD: 1.574, Width: .47	
BB974	AYP # 129895	Bearing Lower bearing in triangle style quill, SS # 82-225 130794 and 143651, Use on 38", 42", 44", 46" and 50" mowers ID: .787", OD: 1.851", Width: .55"	







BLUEBIRD

Part #	Replaces OEM #	Application/Description	
BB204	Bluebird # 0315	Bearing with locking collar Fits Blue Bird power rake drive, models F20 & F20B OD: 1.853", ID: .750", Overall Ht.: .843", Bearing Ht.: .553"	





BOBCAT

Part #	Replaces OEM #	Application/Description	
BB973	Bobcat	Heavy duty ball bearing 1-3/8" OD x 1/2" ID x 1" W Use with our # 72-746 and # 72-747 Extended inner races	
SB33	Bobcat # 35008N	Precision spindle bearing 2.4375" OD x .987" ID x .670" W Top & bottom bearing on spindle assembly 6305-2RS	
BCB1	Bobcat # 33050	Bushing For 6" support arm, Use on our # 48-200 OD: 1", ID: .705", Width: 1.1875"	
BCB2	Bobcat # 48053-2A Scag # 48100-02	Bronze bushing 1-1/4" OD x 1" ID x 3/4" W 1-5/8" flange dia. x 1/8" thick Fits our # 48-208 caster support arm	
SP100	Bobcat # 64163-14	Spindle washer, pack of 10 1-1/4" OD x 3/4" ID x 1/4" W	

BOBCAT continued

Part #	Replaces OEM #	Application/Description	
SP400	Bobcat # 64163-22	ID: 1", OD: 1-3/4", Thick: 1/2", pack of 10 1/2" caster yoke spacer	
BB45	Bobcat # 64163-12	Spindle washer, pack of 10 1" OD x 5/8" ID x 1/4" W	
SP300	Bobcat # 64163-22A	Yoke spacer, pack of 10 Fits 36" and 48" variable and 5 speed mowers with 9" wheels. Also 32", 36", 48" and 61" mowers with 280/250-4 wheels Use with front casters on ZTR 61" and 74" riders 1/2" X 7/8" ID	
SAS1	Bobcat # 43180 Scag # 43022	Spanner bushing Fits our # 72-707 and # 72-795 wheels 5/8" OD x 1-1/2" OD x 4-1/4" L	
WAB354RB	Bobcat # 38273 Bobcat # 38274	Wheel bearing kit Fits our # 72-706	
BAS1	Bobcat # 43073A	Spanner bushing for 36" and 48" cut mowers Fits our # 72-750 1" OD x 3/4" ID x 3-1/2" L	



BUNTON

Part #	Replaces OEM #	Application/Description	
SB33	Bunton # PL0609	Precision spindle bearing 2.4375 OD x .987 ID x .670 W 6305-2RS (Use our # 45-401 for heavy duty)	
BB971	Bunton # PL4969	Spindle bearing Fits new style mowers ID: .625", OD: 1.374", Width .43"	
BB207	Bunton # PL0941	Wheel bearing Fits our # 72-760 wheel, use on 36"-61" walk-behinds ID: .75", OD: 1.375", Width: .487"	
UFBK1	Bunton # PL0878 Bunton # PL0832 Kees # 363161	Flange & bearing kit Includes bearing and 2 flanges	
SP100	Bunton # PL0417	Yoke spacer, pack of 10 For 6" wheel on old style 32", 36", 48" and 52" mowers ID: 3/4", OD: 1-1/4", Width: 1/4"	



CASE

Part #	Replaces OEM #	Application/Description	
BBR95	Case # C-28971	Spindle bearing ID: .75", OD: 1.781", Width: .6075"	

CUB CADET

Part #	Replaces OEM #	Application/Description	
BB974	Cub Cadet # ST207	Spindle bearing ID: .787", OD: 1.851", Width: .55"	
BBR95	Cub Cadet # 465003R91	Bearing	
	Cub Cadet # 470880R91	Spindle bearing for mowers ID: .75", OD: 1.781", Width: .6075"	

DIXON

Part #	Replaces OEM #	Application/Description	
BBR95	Dixon # 6011	Spindle bearing ID: .75", OD: 1.781", Width: .6075"	
BB58		Wheel bearing Fits Dixon wheel # 1022, our # 72-765 and # 72-767 ID: .625", OD: 1.375", Width: .521"	
BB982	Dixon # 1701 John Deere # JD8597 Grasshopper 120081 Dixie Chopper # 30218	Bearing for spindle assembly Fits 30", 40" and 50" ZTR chain drive OD: 52mm, ID: 1", Width: 21-1/2mm	

ENCORE

Part #	Replaces OEM #	Application/Description	
SB33	Encore # 363146	Spindle bearing Blade spindle bearing on walk-behinds ID: .987", OD: 2.4375", Width: .67"	



EXMARK

Part #	Replaces OEM #	Application/Description	
SB33	Exmark # 303057	Bearing Blade spindle bearing ID: .984", OD: 2.4375", Width: .67"	



FERRIS

Part #	Replaces OEM #	Application/Description	
SB33	Ferris # 1520828	Bearing Blade spindle bearing on 48", 52" and 61" mowers ID: .987", OD: 2.4375", Width: .67"	

GRAVELY

Part #	Replaces OEM #	Application/Description	
BB95	Gravely # 38199	Tapered roller bearing Spindle bearing on 36", 40" and 50" mowers ID: 1", OD: 1.988", Width: .608"	
BB207	Gravely	Wheel bearing Fits wheel # 37797, our # 72-780 ID: .75", OD: 1.375", Width: .487"	

HONDA

Part #	Replaces OEM #	Application/Description	
BBR95	Honda # 91102-UA4003	Spindle bearing ID: .75", OD: 1.781", Width: .6075"	
BB974	Honda # 91102-VAO-13 Code # 3175999	Top crank bearing ID: .787", OD 1.851", Width: .55"	

JACOBSEN







Part #	Replaces OEM #	Application/Description	
SB33	Jacobsen # 552184	Bearing Spindle bearing for 36" and 48" Crew Chief and Crew King mowers ID: .987", OD: 2.4375", Width: .67"	



TRIMMER PARTS
& ACCESSORIES

SEE PAGE 4



JOHN DEERE

Part #	Replaces OEM #	Application/Description	
BBR95	John Deere # JD9296	Fits spindles on mowers up to 48" cut prior to 1988 OD: 1.781", ID: .750", Width: .610" Z9504AB (Use our # 45-402 for heavy duty) (FAFNIR)	
BB95	John Deere # JD8253 John Deere # JD8933	Bearing and race kit Used in gearbox on Model 160 rear mower (up to SN# 505035), the gearbox on model 60 mower on Model 400 tractors, main gear case bearing on 47" 2 stage snowblower ID: 1.00", OD: 1.988", Width: .608"	
BB971	John Deere # M47144 John Deere # PT8891	Bearing Edger shaft bearing for model # 2, #3 and 3K edgers ID: .625", OD: 1.374", Width: .43"	
BB207	John Deere # PT8894	Wheel bearing For wheel # PT8639, our # 72-760 ID: .75", OD: 1.375", Width: .487"	
BB974	John Deere	Spindle bearing Blade spindle bearing on new style 48" and 54" mowers ID: .787", OD: 1.851", Width: .55" For heavy duty use, use # 45-403.	
SP100	John Deere # PT8886	Spacer, pack of 10 Yoke spacer on early 32", 36", 48" and 52" mowers with 6" wheel assembly ID: .75", OD: 1-1/4", Width: 1/4"	

K & S

Part #	Replaces OEM #	Application/Description	
BB6200ZZ K & S		Bearing Edger shaft bearing ID: .3939", OD: 1.181", Width: .3543"	

LAWN BOY/GILSON

Part #	Replaces OEM #	Application/Description	
BUO75	Lawn Boy # 678782 Lawn Boy # 681904	Flange bronze bushing ID: 1/2", OD: 7/8", Width: 7/8"	
B975	Lawn Boy # 703275 Gilson # 236544	Bearing Use in our # 82-215 quill assembly ID: .669", OD: 1.574", Width: .47"	
BB95	Lawn Boy # 703809 Lawn Boy # 703210 Gilson # 1045 Gilson # 1046	Bearing kit Use in tiller gear boxes ID: 1.00", OD: 1.988", Width: .608"	



LAWN BOY/GILSON continued

Part #	Replaces OEM #	Application/Description	
BB601	Lawn Boy	Bearing Use in Silver Streak # 72-500 and # 72-508 wheels ID: .500", OD: 1.125", Width: .435"	



LITTLE WONDER

Part #	Replaces OEM #	Application/Description	
BLW10	Little Wonder # 124	Precision ball bearing 6203ZZNR with snap ring OD: 1.574", ID: .669", Width: .471"	



McLANE

Part #	Replaces OEM #	Application/Description	
BB971	McLane # 2036	Bearing Edger shaft bearing, Use with our # 41-478 ID: .625", OD: 1.375", Width: .43"	
BB991	McLane # 1002	Handle bearing for edgers and mowers 29/32" OD x 7/16" ID x 9/16" L	



MTD

Part #	Replaces OEM #	Application/Description	
BB971	MTD # 741-0155	Upper wheel drive case bearing on 430 and 437 tillers, Shaft bearing for 586 edger, Upper chain case bearing on 030 and 406 rear tine tiller, 99502H ID: .625", OD: 1.375", Width: .43"	
BB974	MTD # 741-0919	Bearing Use in blade quills, many MTD edgers, spindle bearing on 993 - 50" cut, Drive plate shaft bearing on 980 snowthrowers, Intermediate drive bearing on 491, 756, 831 and 832 snowthrowers and tiller attachments 6204ZZ ID: .787", OD: 1.851", Width: .551"	
B975	MTD # 741-0124	Bearing Blade shaft bearing on edgers Models 603 and 620 ID: .669", OD: 1.574", Width: .47"	





MURRAY

Part #	Replaces OEM #	Application/Description	
BB971	Murray	Lower bearing in quill Use in our # 82-243 quill assembly 99502H ID: .625", OD: 1.374", Width: 7/16"	
BB951	Murray # 91334	Bearing Front wheel bearing for tractors	
BB983	Murray	Quill bearing and spacer kit for all Murray tractors and riders, Includes bearings and spacer: Our # 45-202, # 45-203 and # 82-244	



NOMA/AMF

Part #	Replaces OEM #	Application/Description	
B975	AMF/Noma # 49562	Ball bearing 1.574" OD x .660" x .472" W 6203-2RS Use in OEM quill assemblies and our # 82-493 and # 82-514	
BBG79	AMF/Noma # 39979	Front wheel bushing 1-3/8" OD x 3/4" ID x 5/8" W	



ROPER - See AYP**SCAG**

Part #	Replaces OEM #	Application/Description	
SB94	Scag # 48668 Scag # 48005-04 Scag # 48005-05	Bearing race kit Bearing for new style blade spindle assemblies Rear wheel bearing on rider models ST12B, 13K, 17KA, 18KH ID: 1", OD: 1.988", Width: .608"	
B975	Scag # 48102	Bearing Transmission idler pulley bearing on ST12B, 13K, 17KA, 18KH riders Idler bearing on SM48, SM61, SM72 decks ID: .669", OD: 1.574", Width: .47"	
BB971	Scag # 48224	Bearing Jackshaft bearing on belt drive walk-behind models. Neutral return bearing on ZTR models. ID: .625", OD: 1.374", Width: .43"	
SB33	Scag # 48101-02	Bearing Bearing for old style blade spindle assemblies ID: .987", OD: 2.4375", Width: .67"	







SCAG (continued)

Part #	Replaces OEM #	Application/Description	
BRB2	Scag # 48100-01 Encore # 363007 Exmark # 303044 Snapper # 7-6514	Bushing for caster support arm Fits our # 48-203. Also steering shaft bushing for pivot wheel on 12, 13 and 17 HP Turf Runner. Flange OD: 1-1/2", OD: 1-1/8", ID: 7/8", Ht: 1"	
BCB93	Scag # 48100-05	Idler arm shaft spacer Fits 32", 36", 40", 48", 52", 61" and 72" decks. ID: 3/4", OD: 7/8", Ht.: 1/2"	









SIMPLICITY

Part #	Replaces OEM #	Application/Description	
BB971	Simplicity # 1665521	Bearing ID: .625", OD: 1.375", Width: .43"	
BB974	Simplicity # 118011	Spindle bearing ID: .787", OD: 1.851", Width: .55"	



SNAPPER

Part #	Replaces OEM #	Application/Description	
BB207	Snapper # 1-5474 Snapper # 1-0943 Snapper # 1-1807	Drive disc bearing, Lutco Use in 5-0618 wheel assembly, Our # 72-728 and # 51-000	
SB33	Snapper # 7-6510	Precision spindle bearing Fits older style, single belt drive 32", 36" and 48" mowers, 6305-2RS ID: .987", OD: 2.4375", Width: .670"	
BB206	Snapper	Flanged ball bearing Extended inner race For 7", 8" and 9" wheels ID: 7/16", OD: 1-1/8", Width: 13/16"	
BB205	Snapper # 1-8767	Precision ball bearing 162ZZNR with snap ring For our # 79-605/610 height adjusters Fits all self-propelled models ID: .5625", OD: 1.375", Width: .4375"	
BB94R	Snapper # 1-2296	Rear axle bearing Fits 26" - 33" riders, Right side ID: 1-1/8", OD: 1-5/8", Width: 1-1/2" Flange OD: 1-3/4"	
BB94L	Snapper # 5-0918	Rear axle bearing Left side, Fits 26" - 33" riders ID: 3/4", Lg. OD: 1.750", Sm. OD: 1.6255" Width: 1.7506"	



SNAPPER continued

Part #	Replaces OEM #	Application/Description	
BB208	Snapper # 1-2304	Hex shaft bearing All 21" self-propelled mowers ID: 3/8", OD: 1", Width: 5/16"	
OP1024	Snapper # 1-1024	Oil filler plug For transmissions on riders and tractors	
BP972	Snapper # 1-0986	King pin bushing ID: 49/64", OD: 13/16", Width: 43/64"	
BP973	Snapper # 1-0694	Nylon bushing Steering bushing (bottom) nylon ID: 5/8", OD: 11/16", Width: 43/64", Flange OD: 1"	
BP971	Snapper # 1-3321	Plastic tie rod bushing ID: 25/64", OD: 1/2", Width: 25/64"	
BBR58	Snapper # 1-0756 Snapper # 79339	Bearing and clip Sprocket and shaft bearing ID: .625", OD: 1.375", Width: .431"	
BBR95	Snapper # 1-0696 Snapper # 1-3313	Bearing Spindle bearing on riding mowers ID: .75", OD: 1.781", Width: .6075"	
BB974	Snapper # 1-2828	Bearing Spindle bearing on old style tractors ID: .787", OD: 1.851", Width: .55"	
KB2	Snapper # 7-6514 Kees # 363194	Caster yoke support bushing OD: 1.125", ID: .885", Ht: 1"	

TORO

Part #	Replaces OEM #	Application/Description	
BB95	Toro # 46-8530	Bearing cone and race For 36", 44" and 52" spindles ID: 1", OD: 1.988", Race width: .418" Brg. width: .608"	
B975	Toro # 38-7820	Bearing Auger shaft bearing for #S-200, 620, CCR2000 snowthrowers ID: .669", OD: 1.574", Width: .47"	
BB974	Toro # 47-1490	Bearing Fits rear engine riders, engine models 725, 832, 1132, 1232	

YAZOO

Part #	Replaces OEM #	Application/Description	
BB971	Yazoo # 204-020	Bearing ID: .625", OD: 1.374", Width: .43"	
BBR95	Yazoo # 204-060	Bearing Spindle bearing on old style 60" and 72" mowers ID: .750", OD: 1.781", Width: .6075"	



MUFFLERS!
SEE PAGE 216

NEW!

ELECTRIC STARTERS!

SEE PAGE 242

